

HYVA PISTON PUMPS



BENT AXIS TYPE

Hyva

piston pump type : piston pump 040L-RH-4H-BAHP-3/4-1 1/4

part number : 145 69 016

Page 1 / 2

rotation : clock wise seen from front side of pump



Fluid	Mineral or synthetic compatible with the following seals: HNBR				
Kinematic viscosity suggested	Average ambient temp. (°C)	< -40	-40+10	10+35	> 35
	VG (cSt = mm²/s)	16	22	32	46
Optimale kinematic viscosity			VG= 10 cSt + 100 cSt		
Max kinematic viscosity suggested at the start-up			VG= 750 cSt		
Viscosity index suggested	VI > 100	Working temperature		-40°C + 140°C	
Oil filtering			> 200 bar: 10 µm < 200 bar: 25 µm		
Inlet pressure			0,85 ± 2 bar absolut		
Pump rotation			Right		
Verify that pump is, at least, 100 mm under the minimum level of the tank. Before starting the pump bleed the air.					

Dimensions in mm

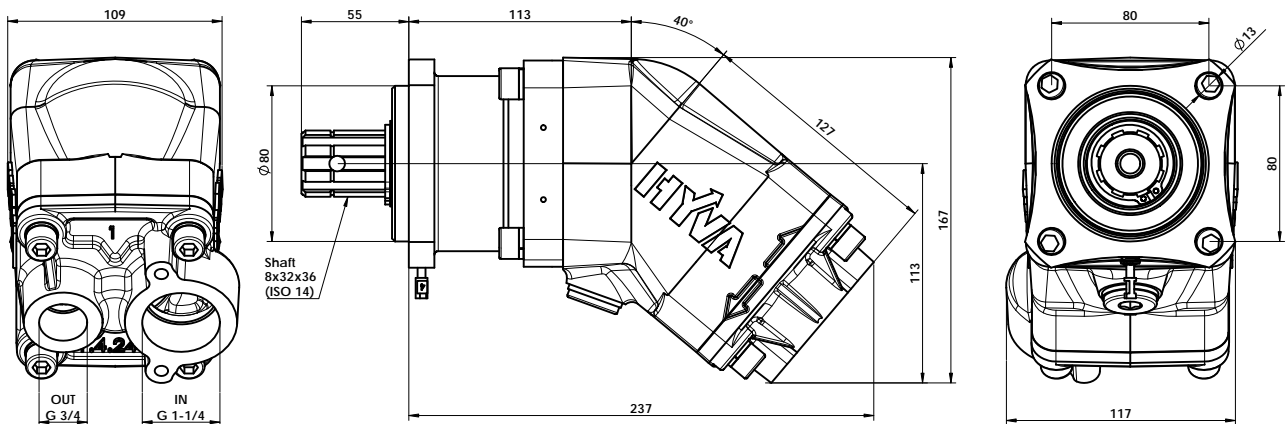

DISPLACEMENT	PRESSURE		SPEED			MIN. SPEED	IN ISO 228	OUT ISO 228	WEIGHT
	P1	P3	V1	V2	V3				
41,25 cm³/rev	350 bar	400 bar	2700 rpm	1900 rpm	2500 rpm	300 rpm	G 1-1/4	G 3/4	12,3 Kg

P1 = Max. continuous pressure (100%)
P3 = Max. peak pressure (6 sec.max)

V1 = Max. continuous speed without load
V2 = Max. continuous speed
V3 = Max. intermittent speed

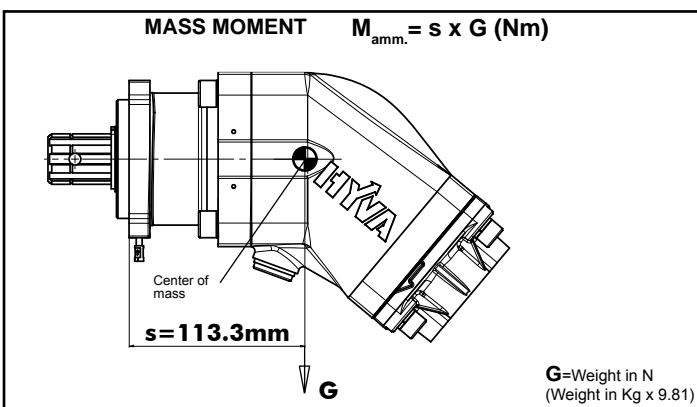

WARNING

Remove the protection plug and install the leakage system fitting.



WARNING: if oil leaks through the transparent tube the pump should be replaced immediately to avoid gearbox damage.

SEAL KIT

Part.no **02410021**

HYVA PISTON PUMPS



BENT AXIS TYPE

Hyva

piston pump type :

piston pump 040L-RH-4H-BAHP-3/4-1 1/4

part number :

145 69 016

Page 2 / 2

rotation :

clock wise seen from front side of pump

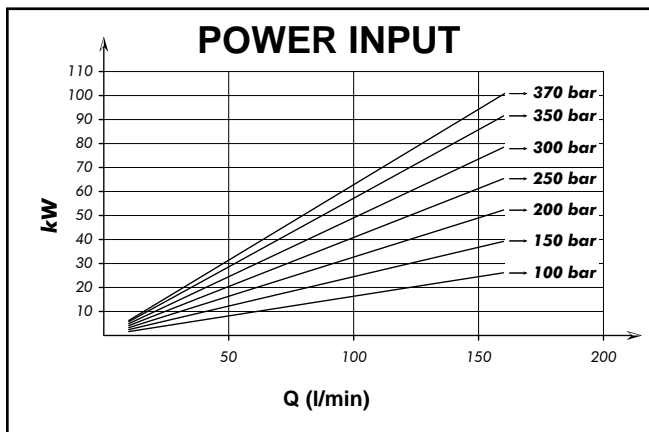
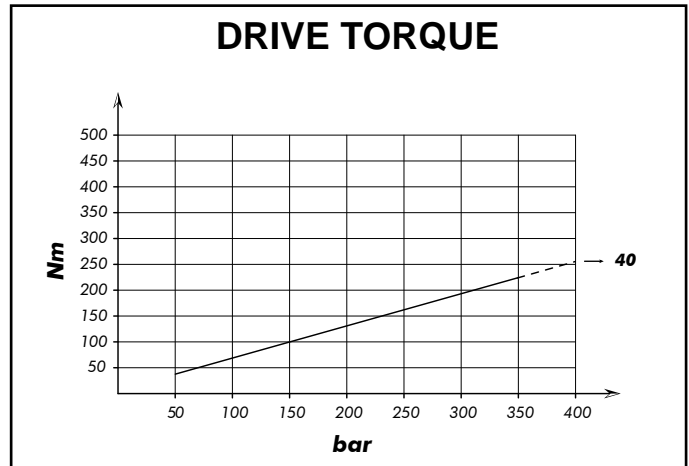
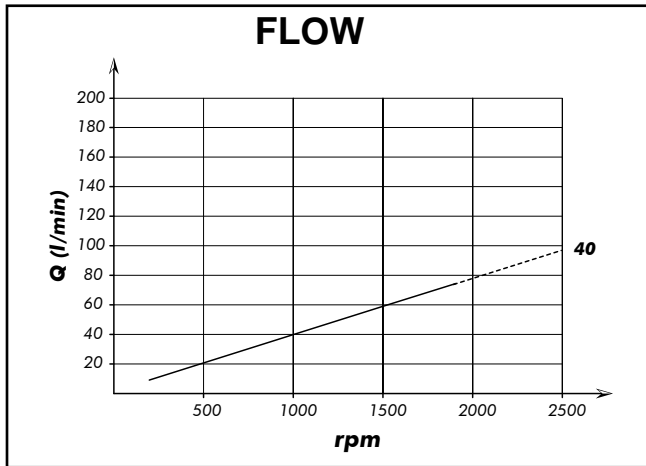

suction hose	LP 20	LP 24	LP 28	LP 32
flow [lpm]	60	60-85	60-120	120-150
pump size	max. rpm	max. rpm	max. rpm	max. rpm
25	2300			
34	1700	2400		
40	1400	2100		
47		1700	2400	
64		1300	1700	2300
80			1400	1800
84			1300	1700
96				1500
108				1400
130				1100