

# HYVA DIVERTER VALVE



DIVERTER VALVE - MANUAL OPERATING

Hyva

tipping valve type: diverter-valve man.-3/3-150L-400B-3/4"

working pressure:

400 bar

page # 1 / 1

part number valve:

021418011

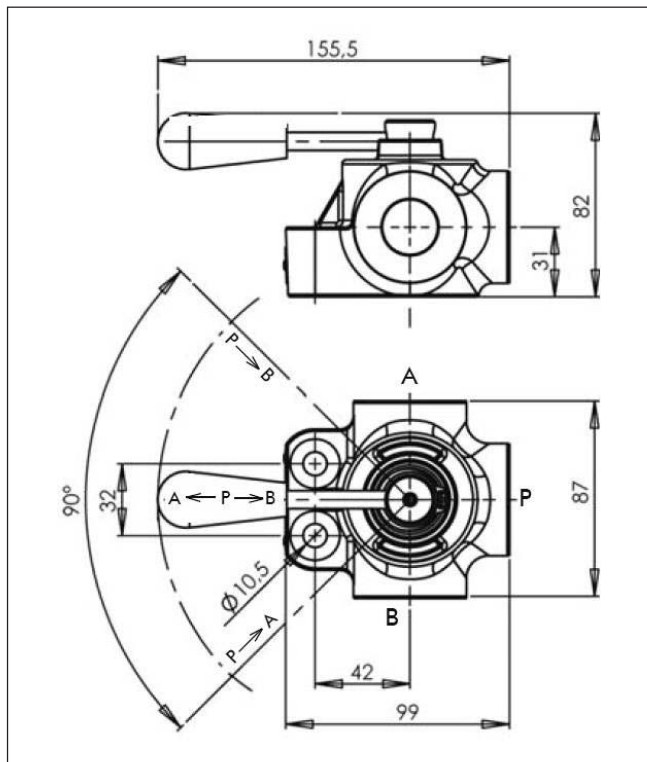

## specifications

hydraulic connections	: G3/4"
max. working pressure	: 380 bar
max. peak pressure	: 400 bar
max. advised flow	: 150 L/min.
oil type	: ISO VG 68
temperature range	: -25 / + 80 °C
mass	: 2.15kg

## general information

Manual 3-way high pressure diverter valve to control 2 pressure lines separately. Especially designed to afford pressure peaks of applications like Tipper/crane or hook loader/crane.

- Pressure up to 400 bar.
- Open center scheme to prevent dangerous shocks while switching.
- Galvanized body and nickel spool.

## Δp - Flow characteristic

The graph refers to oil type ISO VG 68 at 50°C

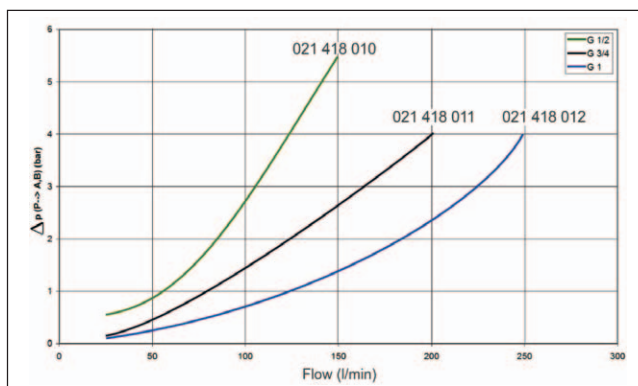

## hydraulic symbol

